



PUMA V series

PUMA V400/V550

High Performance Vertical Turning Center



PUMA V series

PUMA V400/V550

The vertical turning center is designed for long term accuracy, heavy duty cutting and to minimize floor space. Its powerful spindle drives, meehanite casting and integral box guide way provide unsurpassed rigidity.



New Standard for Unsurpassed High Productivity, High Speed and High Precision



PUMA V400 series

Main Spindle

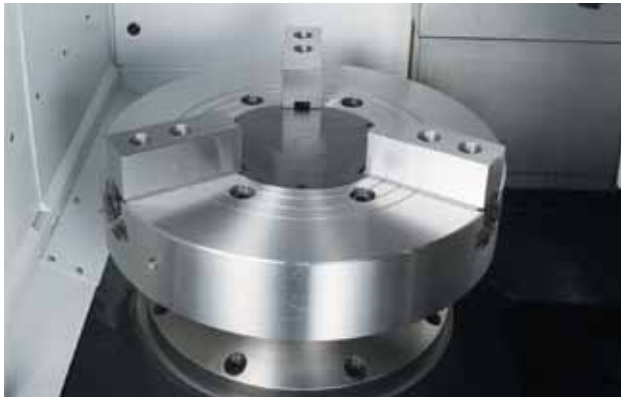

The cartridge type spindle with A2#8 spindle nose assures high capability and easy of maintenance. Especially rigid coupled bearing assembly is to support heavy weight workpiece and reduces thermal growth in long run operation.

Max. spindle speed Motor (30 min)
3000 r/min **22 kW (29.5 Hp)**

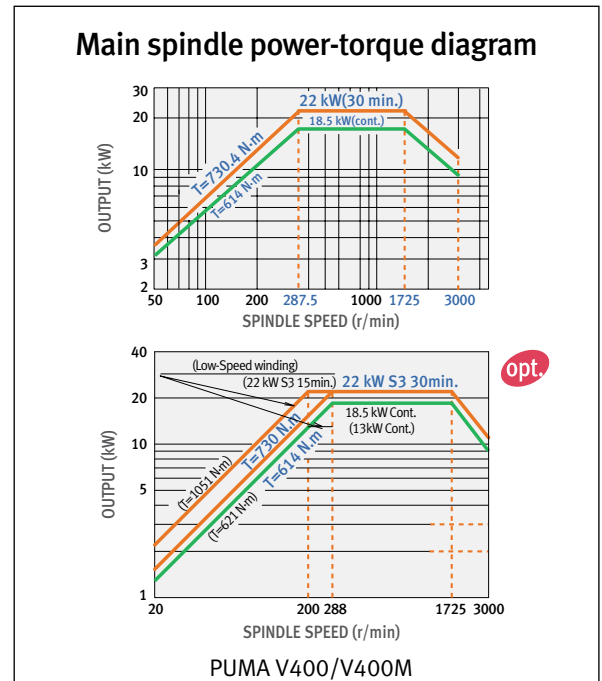

Rigidity Bed and Wide Working Range



X-axis travel
268 mm
 (10.55 inch)

Z-axis travel
488 mm
 (19.21 inch)

Meehanite cast iron bed and integral box guideways provide the rigid foundation needed for superior precision, deep cutting and rugged dependability. The heavily-ribbed and exclusive bed design provides unsurpassed rigidity, enabling heavy cutting and assuring stability for exceptional accuracy and superior

Machining range



A : Max. turning diameter

496 (420) mm
 (19.53 (16.54) inch)

B : Max. turning length

461 (400) mm
 (18.15 (15.75) inch)

() : on PUMA V400M

Rapid Traverse



X-axis

20 m/min
 (787.4 ipm)

Z-axis

20 m/min
 (787.4 ipm)

BMT Turret (PUMA V400M)



Index time (1-station swivel)

0.15 s

No. of tool station

12 (12+12)^{*1} stations
8 (8+8)^{*1} stations (opt)

*1 : PUMA V400-2SP

The large 12 station heavy duty turret features a large diameter Curvic coupling and heavy duty design with unsurpassed rigidity. Turret rotation, acceleration and deceleration are all controlled by a reliable high torque servo motor. Unclamp and rotation are virtually simultaneous. Its fast index response reduces the total cycle time

Rotary tool spindle power-torque diagram

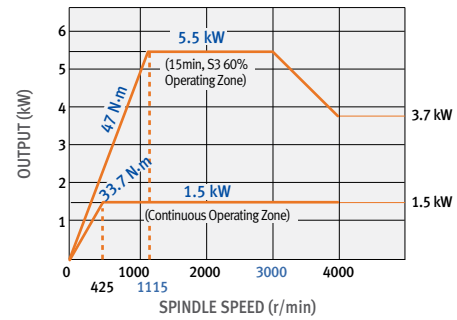

PUMA V400M BMT65P rotary spindle

PUMA V400M Radial BMT Turret

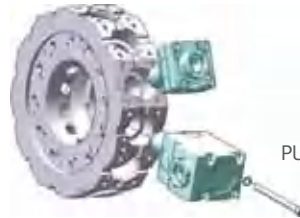

PUMA V400M : BMT65P

Rotary Tool Head

The new rotary tool head confirms the high rigidity and accuracy by simultaneous dual contact between the rotary tool head face and tool holding insert (called Preci-flex adapter) flange face as well as tool head pocket taper

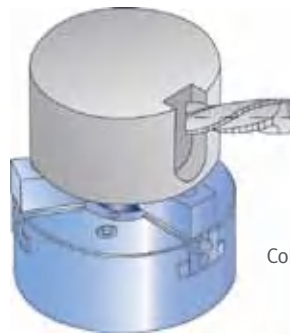

Preci-flex adapter application



Collet application



Double-Paneled Safety Window

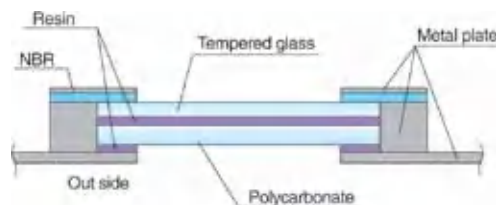

The operator safety can be enhanced through the front door with its shock absorbing laminated glass and double panel construction. The windows without grating also provide a clear view of the machine inside.

PUMA V550 series

Main Spindle

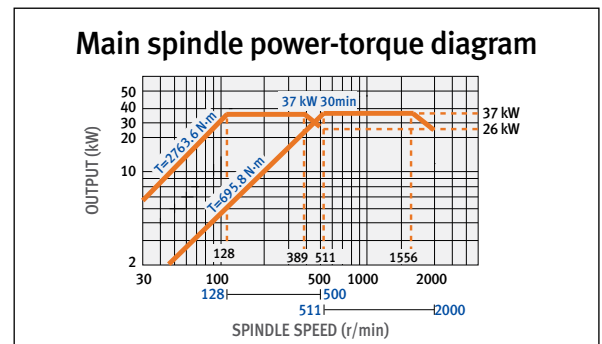
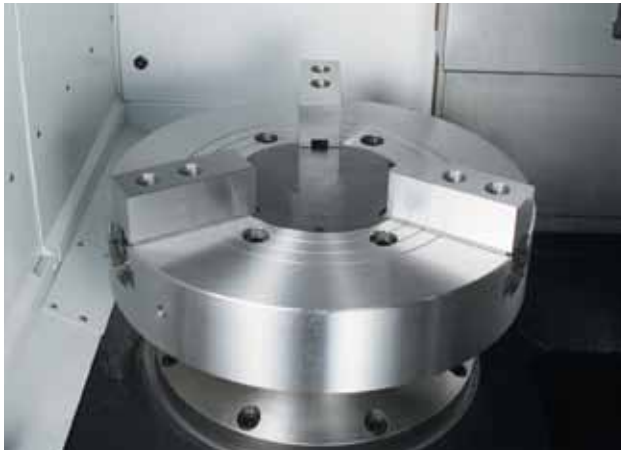

Max. spindle speed Motor (30 min)
2000 r/min 37 kW (49.6 Hp)

The cartridge-type precision spindle is assembled in a temperature controlled clean room. Four rows of high precision roller bearings and two rows of angular contact thrust bearings support the A2#11 American standard type spindle nose. The entire assembly is per-manently grease lubricated, which eliminates routine maintenance and reduces thermal growth. Twin spindle model(PUMA V550-2SP) have an independent direct drive system for each spindle. This permits either synchronous or asynchronous operation to double your productivity, or to machine complete components from each unit.

Rigidity Bed and Wide Working Range



X-axis travel
390 (490)*1 mm
 (15.35 (19.29) inch)

Z-axis travel
780 mm
 (30.71 inch)

*1 : PUMAV550M

The one piece bed and box type column castings are rigid and heavily ribbed. Meehanite cast iron. These castings remain stable even under the heaviest cutting conditions. Fine grained Meehanite cast iron is used for its excellent vibration absorbing characteristics. The cross slide body is fully supported by the saddle in all positions and there is no table overhang.

Workpiece space and interference space

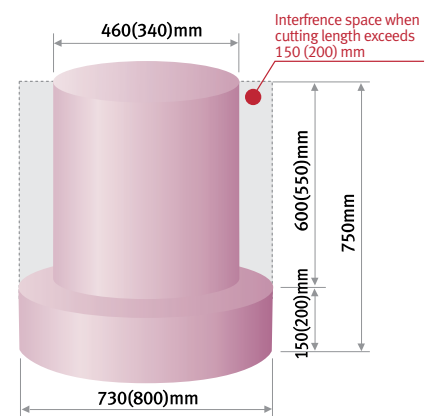

() : PUMA V550M

Rapid Traverse



X-axis
20 m/min (787.4 ipm)

* only PUMA V550M : 12 m/min (472.4 ipm)

Z-axis
16 m/min (629.9 ipm)

BMT Turret (PUMA V550M)



Index time
(1-station swivel)

0.15 s

No. of tool station

**8 (8+8)^{*1}
stations**

^{*1} : PUMA V550-2SP : 8+8

The large 8 station heavy duty turret features a large diameter Curvic coupling and heavy duty design with unsurpassed rigidity. Turret rotation, acceleration and deceleration are all controlled by a reliable high torque servo motor. Unclamp and rotation are virtually simultaneous. Its fast index response reduces the total cycle time required to machine parts.

Rotary tool spindle power-torque diagram

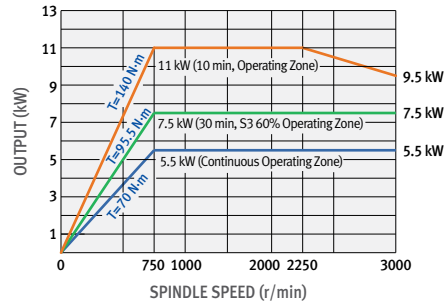

PUMA V550M BMT75P rotary spindle

PUMA V550M Radial BMT Turret

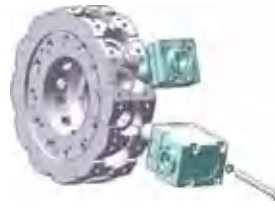

The turret features BMT75P style tooling in which the toolholders are mounted directly to the turret's periphery using 4 large bolts. This type of mounting system allows an extremely high degree of rigidity.

Index time (1-station swivel)

0.25 s

No. of tool station

12 stations

Preci-Flex Ready Rotary Tools

Preci-Flex ready rotary tool holders are available on the milling versions. Preci-Flex is a tooling system that utilizes the existing ER collet taper in the rotary holders. The spindle face is precision ground relative to the taper and there are four drilled and tapped holders in this face. The Preci-Flex adapters locate on both the taper and the spindle face for maximum rigidity.

Preci-flex adapter application

Collet application



Double-Paneled Safety Window

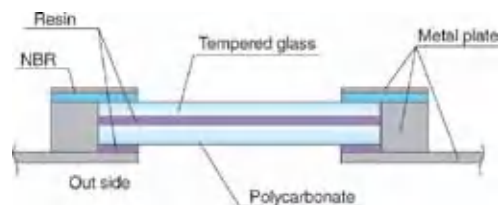

The operator safety can be enhanced through the front door with its shock absorbing laminated glass and double panel construction. The windows without grating also provide a clear view of the machine inside.

Tooling System

Unit: mm (inch)

PUMA V400 / V400-2SP

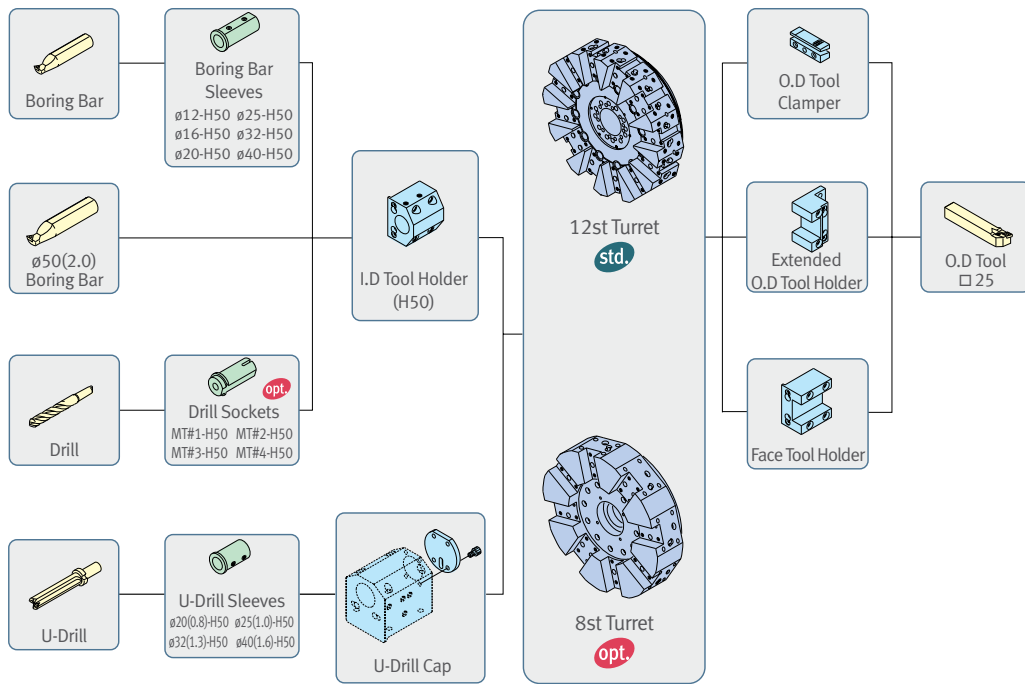

PUMA V400M

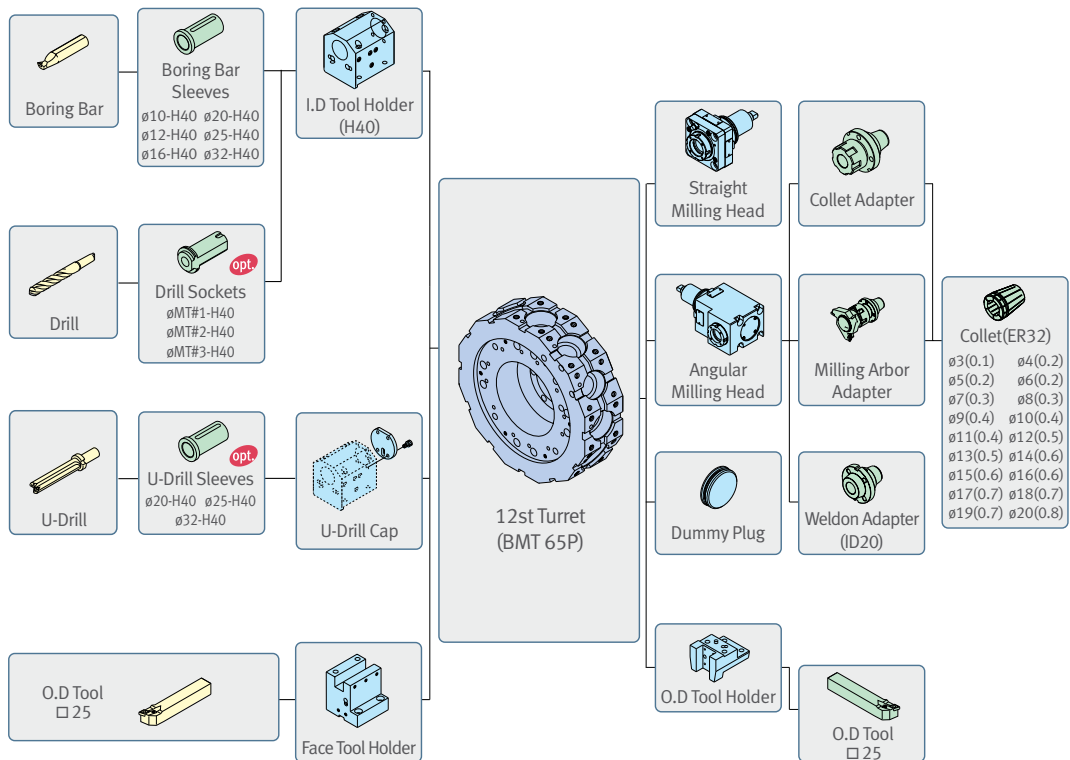

PUMA V550 / V550-2SP

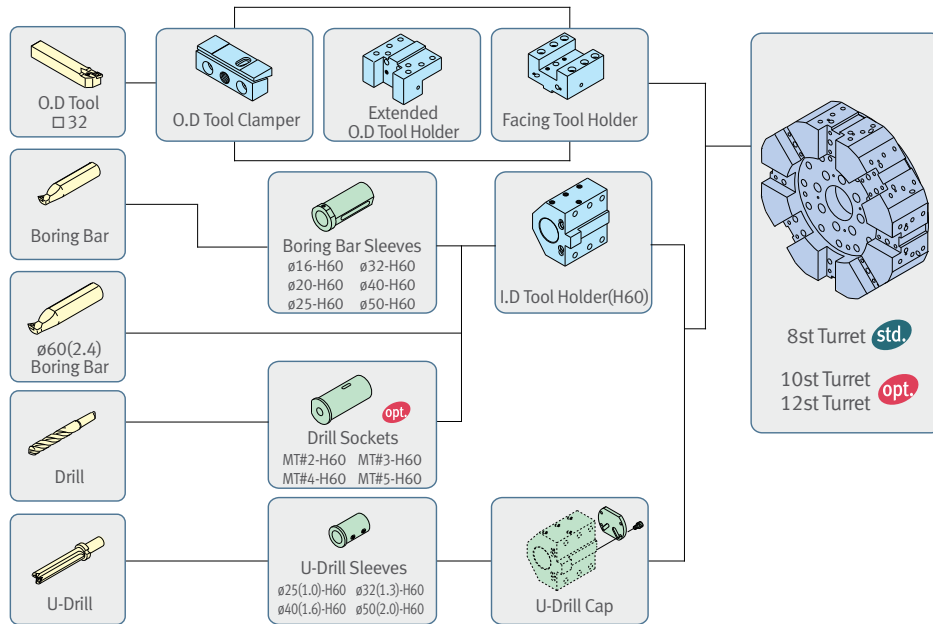

PUMA V550M

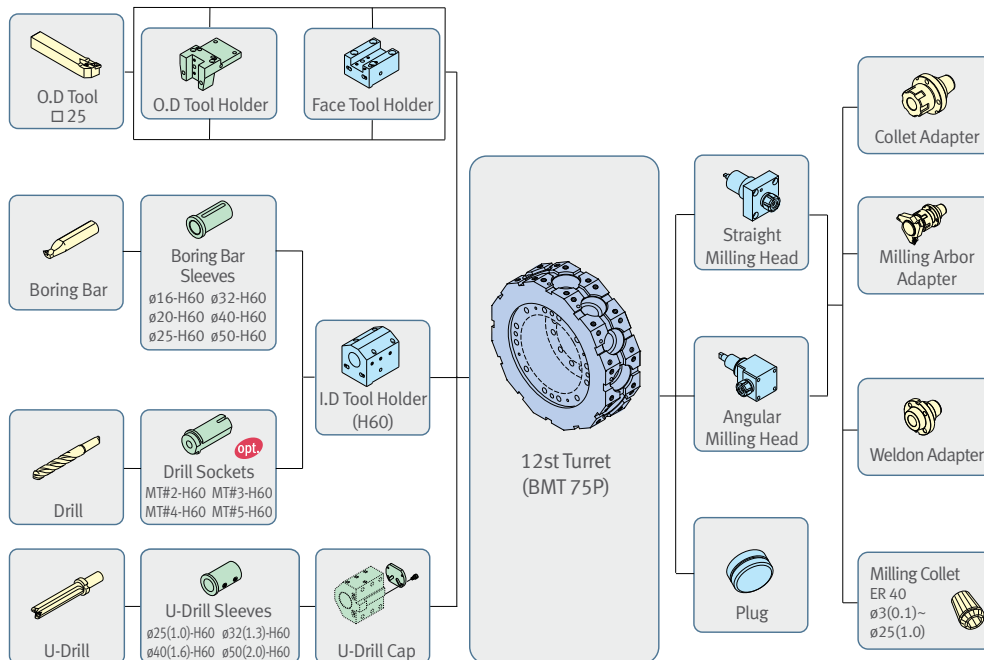

Note) Above tooling system is our recommendation.
 Depending on export condition, the standard tooling packed with the machine can be different.

Tool Interference Diagram

Unit: mm (inch)

PUMA V400/V400-2SP

(1) PUMA V400 : 12 stations

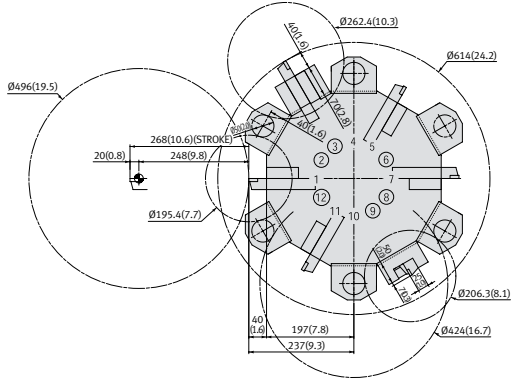

(2) PUMA V400 : 8 stations **opt.**

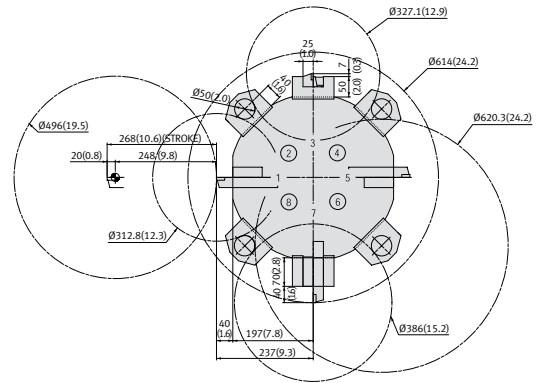

PUMA V400M

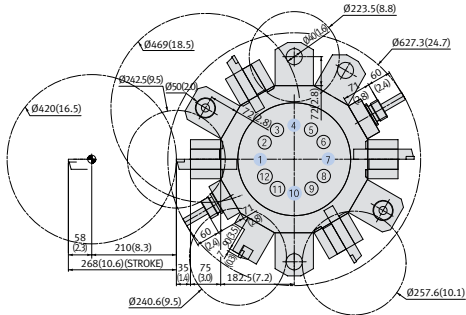

PUMA V550M

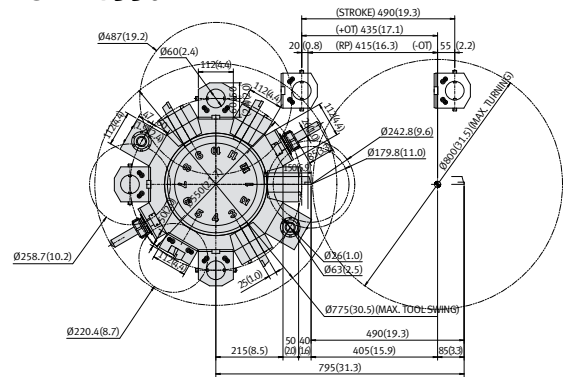

PUMA V550/V550-2SP

(1) PUMA V550 : 8 stations

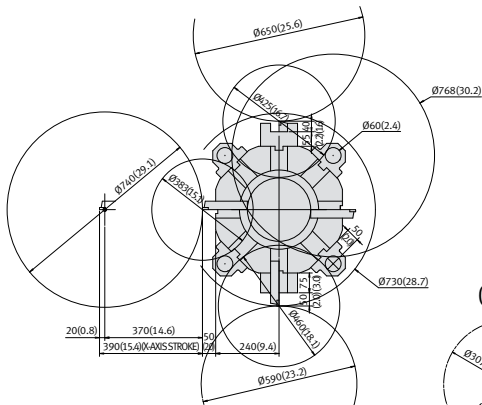

(2) PUMA V550 : 10 stations **opt.**

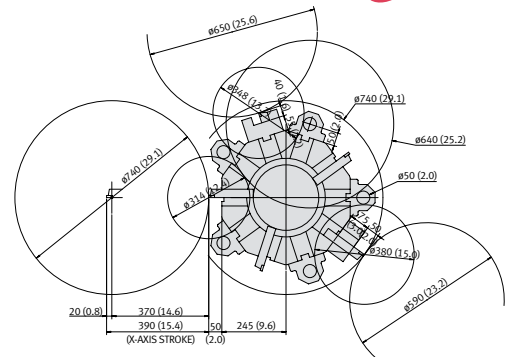

(3) PUMA V550 : 12 stations **opt.**

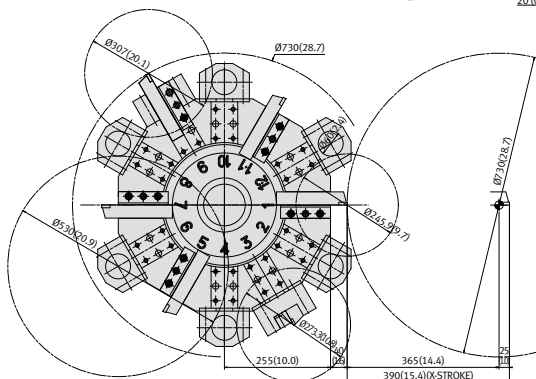

Working Ranges

Unit: mm (inch)

PUMA V400/V400-2SP

OD tool holder range

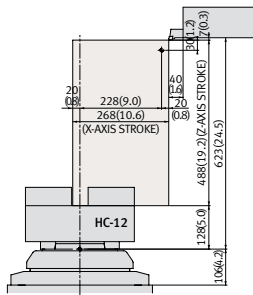

Extended OD tool holder range

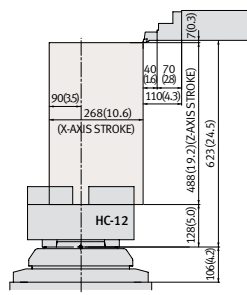

ID tool holder range

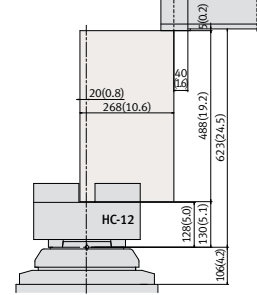

PUMA V400M

OD tool holder range

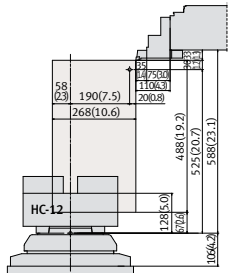

ID tool holder range

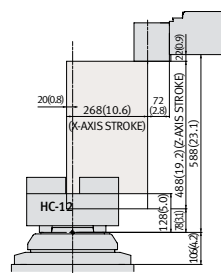

Straight milling unit

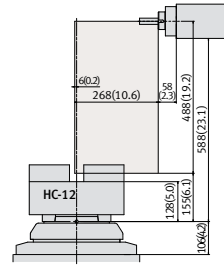

Angular milling head

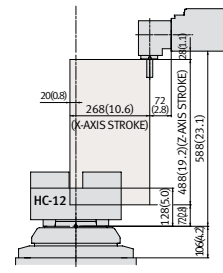

PUMA V550/V550-2SP

OD tool holder range

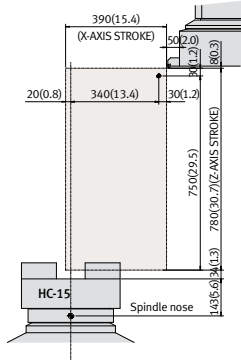

Extended OD tool holder range

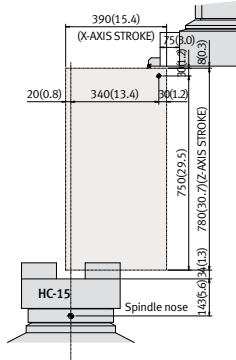

ID tool holder range

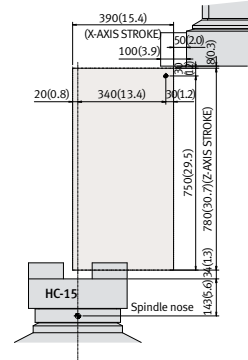

PUMA V550M

OD tool holder range

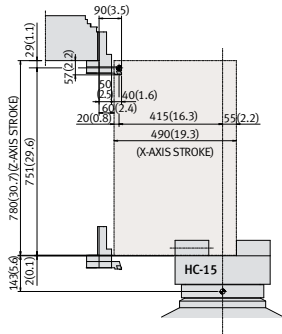

ID tool holder range

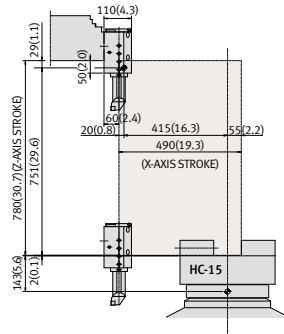

Straight milling unit

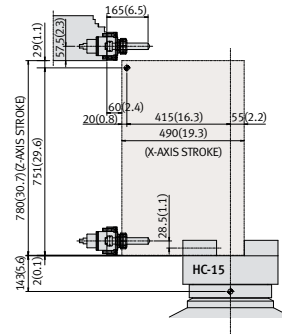

Angular milling head

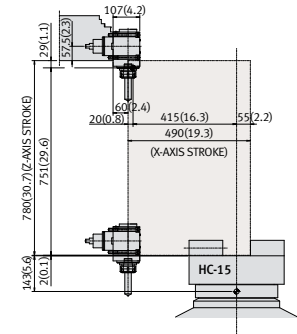

External Dimension

Unit: mm (inch)

PUMA V400/M

Top view

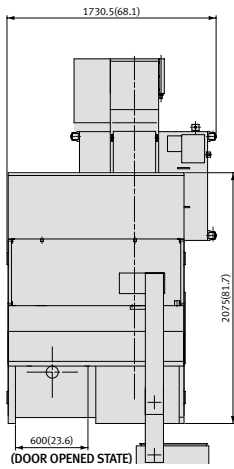

Front view

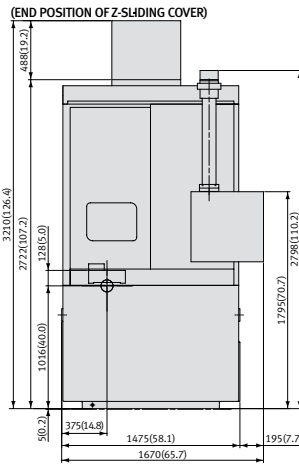

Side view

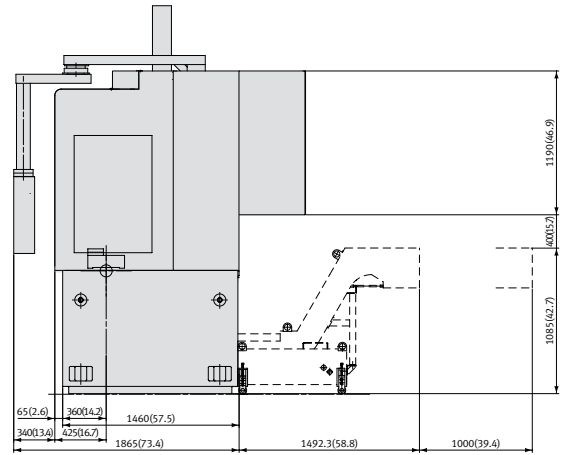

Note) Right Handed Model of PUMA V400 series

PUMA V400-2SP

Top view

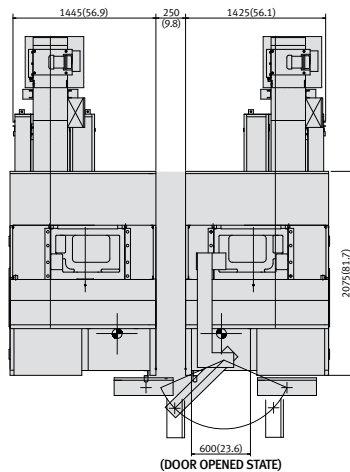

Front view

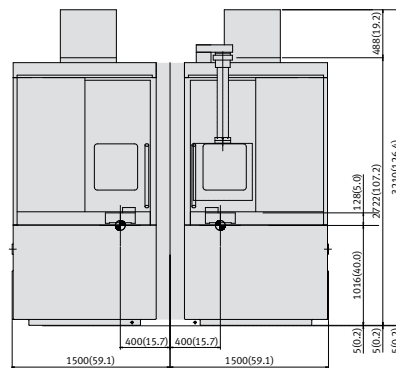

Side view

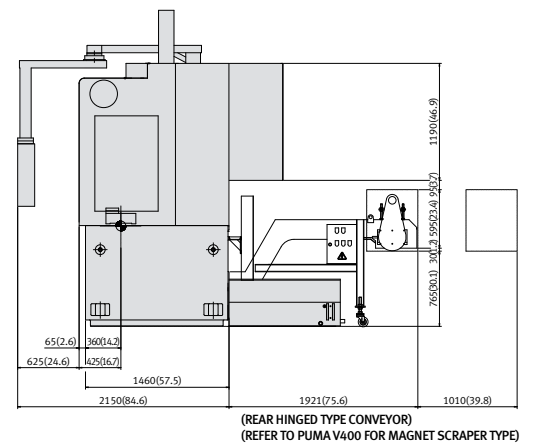

PUMA V550M

Top view

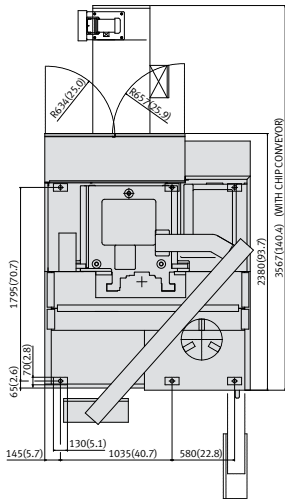

Front view

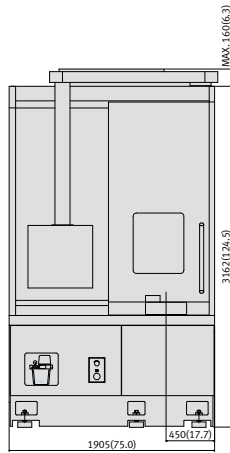

Side view

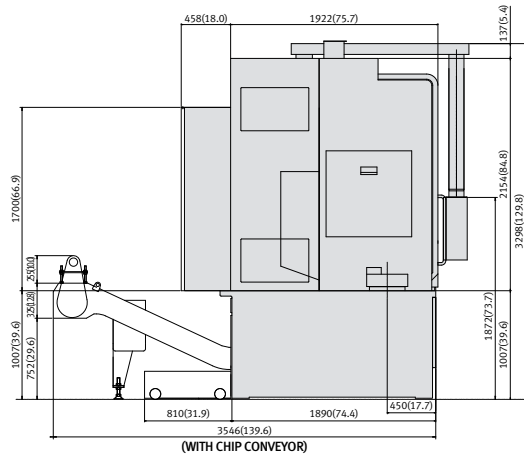

Note) Left Handed Model of PUMA V550 series

PUMA V550/V550-2SP

Top view

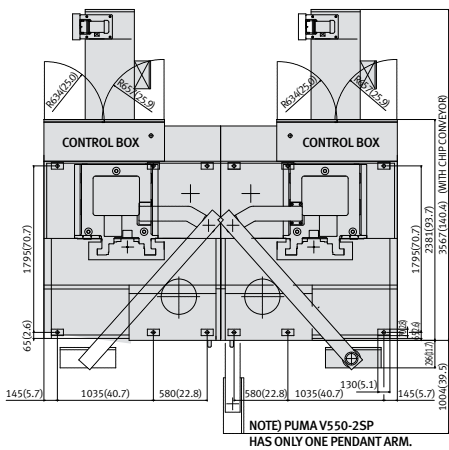

Front view

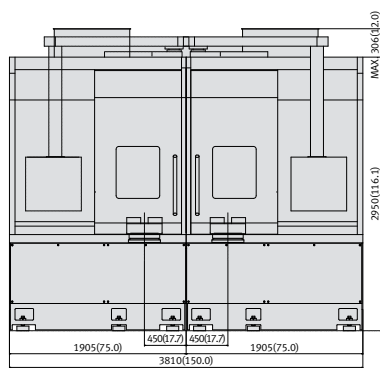

Side view

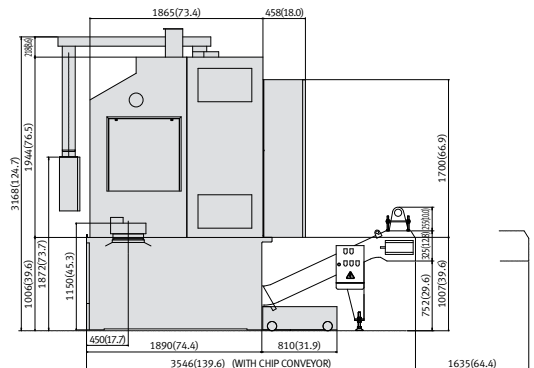

Machine Specifications

Description		Unit	PUMA V400	PUMA V400M	PUMA V400-2SP	PUMA V550	PUMA V550M	PUMA V550-2SP
Capacity	Swing over bed	mm (inch)	610 (24.0)			800 (31.5)		
	Swing over saddle	mm (inch)	500 (19.7)			490 (19.3)		
	Recom. turning diameter	mm (inch)	305 (12.0)			550 (21.7)		
	Max. turning diameter	mm (inch)	496 (19.5)	420 (16.5)	496 (19.5)	730 (28.7)	800 (31.5)	730 (28.7)
	Max. turning length	mm (inch)	461 (18.1)	400 (15.7)	461 (18.1)	750 (29.5)		
Travels	Travel distance	X-axis travel	268 (10.6)			390 (15.4)	490 (19.3)	390 (15.4)
		Z-axis travel	488 (19.2)			780 (30.7)		
	Chuck size	mm (inch)	305(12")			380(15")		
Feedrates	Rapid traverse	X-axis	20			20	12	20
		Z-axis	20			16		
Main Spindle	Spindle speed	r/min	3000			2000		
	Spindle nose	ASA	A2#8			A2#11		
	Spindle bearing diameter (Front)	mm (inch)	130 (5.1)			160 (6.3)		
	Spindle through hole	mm (inch)	90 (3.5)			140 (5.5)		
	Main spindle indexing angle (C-axis)	deg	-	360 (0.001)	-	-	360 (0.001)	-
Turret	No. of tool stations	station	12 {8}	12	12+12 {8+8}	8 {10, 12}	12	8+8 {10+10, 12+12}
	OD tool size	mm (inch)	25 (1.0)			32 (1.3)	25 (1.0)	32 (1.3)
	Max. boring bar size	mm (inch)	50 (2.0)	40 (1.6)	50 (2.0)	60 (2.4)		
	Turret Indexing time (1 station swivel)	s	0.15			0.15	0.25	0.15
	Rotary tool spindle speed	r/min	-	4000	-	-	3000	-
Motor	Main spindle motor power (30min)	kW	22			37		
	Rotary tool spindle motor	kW	-	5.5	-	-	11	-
Power Source	Electric power supply	kVA	40.3	44.7	81	54.4	56.6	103.9
Machine Dimensions	Height	mm (inch)	3210 (126.4)			3260 (128.3)	3390 (133.5)	3260 (128.3)
	Length	mm (inch)	1455 (57.3)		2910 (114.6)	1905 (75.0)		3810 (150.0)
	Width	mm (inch)	2075 (81.7)			2720 (107.1)		
	Weight	kg	6000		12000	9000	9100	18000

{ } : Option

Standard Feature

- Coolant supply equipment
- Controller : Doosan Fanuc i series^{*1}
- Controller : Fanuc 31i^{*2}
- Full enclosure chip and coolant shield
- Hand tool kit, including small hand tool for operations
- Hydraulic chuck & actuating cylinder
- Hydraulic power unit
- Leveling jack screw & plates
- Lubrication equipment
- Soft jaws (total)
- Standard tooling kit (tool holders & boring sleeve)
- Work light

Optional Feature

- Air blast for chuck jaw cleaning
- Automatic door
- Automatic door with safety device
- Chip conveyor & Chip bucket
- Controller : Fanuc 32i^{*1}
- Coolant flushing
- Dual chucking pressure
- Hardened & ground jaws
- Manual tool presetter
- Oil skimmer
- Signal tower (yellow, red, green)
- Chuck clamp confirmation
- Special chucks

* Design and specifications are subject to change without prior notice.
 * Doosan is not responsible for difference between the information in the catalogue and the actual machine.

*1 : PUMA V400/400M/V550/V550M *2 : PUMA V400-2SP, V550-2SP

• The specifications and information above-mentioned may be changed without prior notice.
 • For more details, please contact Doosan

NC Unit Specifications

	Description	Spec.	Doosan Fanuc i series	Fanuc 32i	Fanuc 31i
Controls	Controlled axes		X, Z, C (!)	X, Z, C (!)	X1, Z1, X2, Z2
	Simultaneously controlled axes	Std. 2 axes	4 axes (!)	3 axes (!)	4 axes
Axis Functions	Backlash compensation	0~±9999 pulses	○	○	○
	Cs contouring control		○ (!)	○ (!)	-
	Follow-up / Chamfering on/off		○	○	○
	HRV2 control		○	○	○
	Least input increment	0.001mm / 0.0001"	○	○	○
	Stored stroke check1	Overtravel control	○	○	○
Operation	Automatic operation(memory) / Buffer register		○	○	○
	Handle incremental feed	X1, X10, X100	○	○	○
Interpolation	Search function	Sequence NO. / Program NO.	○	○	○
	1st, reference position return	Manual, G28	○	○	○
	2nd reference position return	G30	○	○	○
	Reference position return check	G27	○	○	○
	Circular interpolation	G02, G03	○	○	○
	Continuous thread cutting		○	○	○
	Dwell	G04	○	○	○
	Linear interpolation	G01	○	○	○
	Multiple threading / Thread cutting retract		○	○	○
	Polar coordinate interpolation		○ (!)	○ (!)	-
Feed Functions	Thread cutting / Synchronous cutting		○	○	○
	Feed per minute / Feed per revolution		○	○	○
	Feedrate override	0 - 200 % (10 % unit)	○	○	○
	Jog feed override	0 - 2000 mm/min	○	○	○
	Rapid traverse override	F0 / 25 / 100 %	○	○	○
Auxiliary & Spindle Functions	Tangential speed constant control		○	○	○
	1st Spindle orientation		○	○	○
	Constant surface speed control		○	○	○
	M-function	M3 digit	○	○	○
	Multi-spindle control		○ (!)	○ (!)	○
Programming Functions	Rigid tapping		○	○	○
	Spindle speed override	0~150%	○	○	○
	Absolute / Incremental programming		○	○	○
	Canned cycle for drilling		○	○	○
	Custom macro		○	○	○
	Decimal point programming / pocket calculator type decimal point programming		○	○	○
	Direct drawing dimension programming		○	○	○
	Manual guide i	Conversational programming	○	○	○
	Maximum program dimension	□ 9 digits	○	○	○
	Multi repetitive canned cycle	G70~G76	○ (!)	○	○
	Optional block skip(without hardware)	Total 9 (Only NC function)	-	○	○
	Sequence number		N5	N8	N8
	Programmable data input	G10	○	○	○
Sub program call	Nested holds	4	10	10	
Tape format for FANUC series 10/11		○	○	-	
Tape format for FANUC series 15		-	-	-	
Work coordinate system selection	G52~G59	○	○	○	
Tool Functions	Auto tool offset		○	○	○
	Tool monitoring system		-	Opt.	Opt.
	Direct input of tool offset value measured B		○	○	○
	Tool geometry / wear compensation	Geometry & wear data	○	○	○
	Tool life management		○	○	○
	Tool nose radius compensation	G40~G42	○	○	○
	T-code function	T2+2 digits	○	○	○
Tool offset pairs		64	64	32	
Tool offset value counter input		-	○	○	
Editing Op. Functions	Background editing		○	○	○
	Expanded part program editing	Copy, Move, Change of NC program	○	○	○
	No. of Registered programs		400ea	500ea	500ea
	Part program editing / Program protect		○	○	○
Setting & Display	Part program storage length*1		640m	640m	640m
	Display of spindle speed and T-code at all screen		○	○	○
	Help function	Alarm&Operation display	○	○	○
Data Input & Output	Self diagnostic function		○	○	○
	Servo setting screen / Spindle setting screen		○	○	○
	Tool path graphic display		○	Opt. (!)	○
Other Functions	I/O interface	RS-232C	○	○	○
	Memory card input and output		○	○	○
	Reader puncher control	CH1 interface	○	○	○
	Ethernet function	Embedded ethernet function	○	○	○
Other Functions	MDI / DISPLAY unit		10.4" color TFT LCD	10.4" color TFT LCD	10.4" color TFT LCD
	PMC system		○	○	○

○: Standard OPT: Option (!): only M type

Fanuc 31i-A : PUMA V550-2SP
PUMA V400-2SP

*1 : Standard Part program length is different on export condition. On the addition of optional functions, its length can be reduced.



Doosan Machine Tools

<http://www.doosanmachinetools.com>

www.facebook.com/doosanmachinetools

Optimal Solutions for the Future

Head Office

Yeonkang Bldg., 6th FL., 270, Yeonji-dong,
Jongno-gu, Seoul, Korea
Tel +82-2-3670-5345 / 5362
Fax +82-2-3670-5382

Doosan Machine Tools America

19A Chapin Rd., Pine Brook, NJ 07058, U.S.A.
Tel +1-973-618-2500
Fax +1-973-618-2501

Doosan Machine Tools China

Room 101,201,301, Building 39 Xinzhuan Highway
No.258 Songjiang District,China Shanghai(201612)
Tel +86 21-5445-1155
Fax +86 21-6405-1472

Doosan Machine Tools Europe

Emdener Strasse 24, D-41540 Dormagen, Germany
Tel +49-2133-5067-100
Fax +49-2133-5067-001

Doosan Machine Tools Japan

#2412, Mita Kokusai Bldg. 1-4-28 Mita,
Minato-ku, Tokyo 108-0073, Japan
Tel +81 3 5730 9013
Fax +81 3 5730 9016

Doosan Machine Tools India

106 / 10-11-12, Amruthahalli, Byatarayanapura,
Bellary road, Bangalore-560 092, India
Tel +91-80-4266-0122 / 121 / 100



ver. EN 160502 SU

* For more details, please contact Doosan Machine Tools.

* The specifications and information above-mentioned may be changed without prior notice.

* Doosan Machine Tools Co., Ltd. is a subsidiary of MBK Partners, a Korean private equity firm. The trademark  DOOSAN is used under a licensing agreement with Doosan Corporation, the registered trademark holder.